

Assembly Instructions for Chair

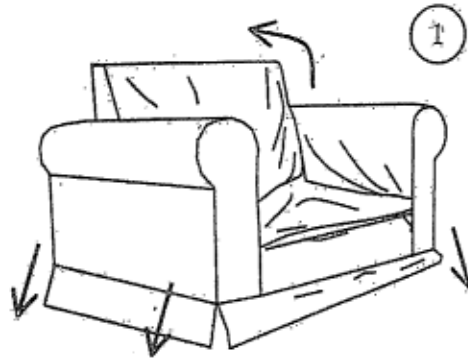

Drape slipcover, pulling down over all main parts of the furniture in muslin. Line up so cover is even with floor on all sides. Tuck into creases using the stitchings and welts as a guide to line up along the edges.

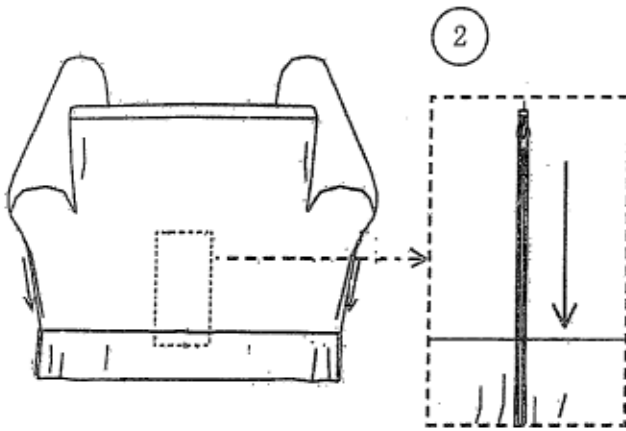

Align all areas and corners and then zip the cover closed.



Insert cushion into zippered cover- Rectangular seat cushion and T-shape back. Fluff them and fill out all corners by regulating them with your hands.

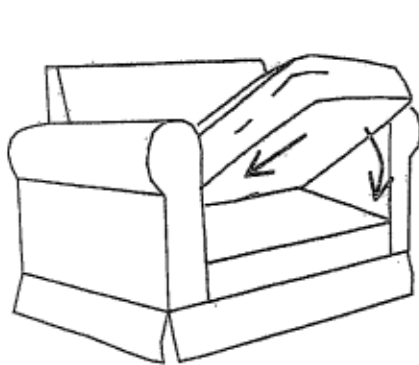

Place seat cushion with zipper closure facing the back. Push down front till flat. Smooth excess fabric and tuck creases on all three sides.

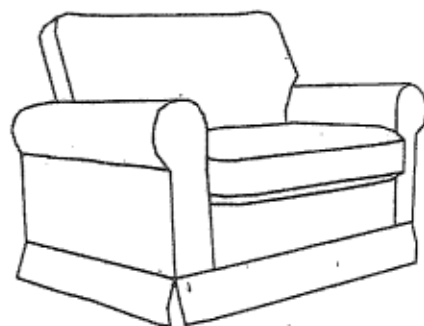

Place back with the zipper closure going down. When finished, your slip cover should fit snugly.

Assembly Instructions for Ottoman

1

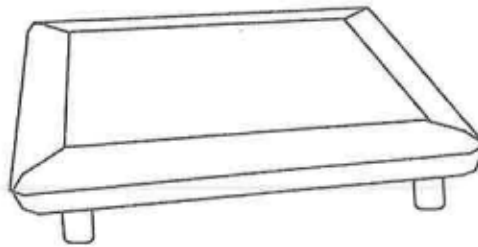

This is the ottoman base with legs.

2

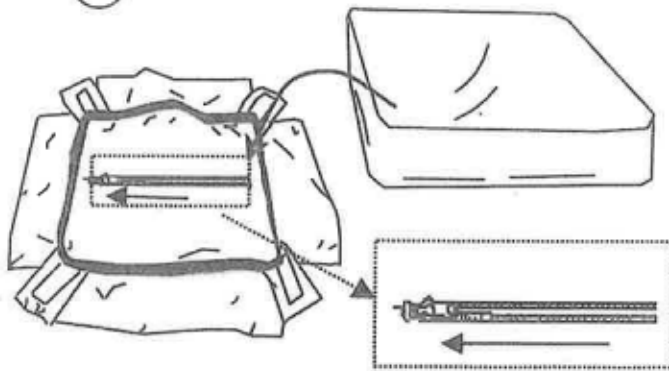

Unzip the zipper on bottom side of the cover. Insert the top cushion into the cover. Fluff and fill out all corners by regulating the top with your hands.

3

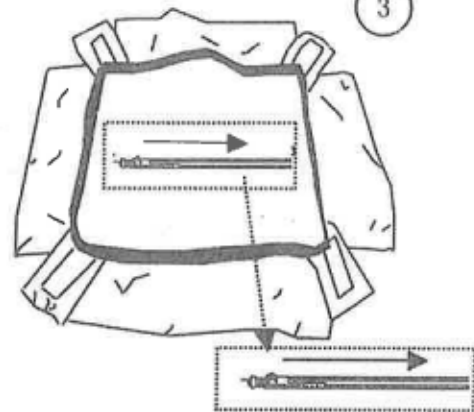

Close the zipper when finished the regulation on top cushion.

4

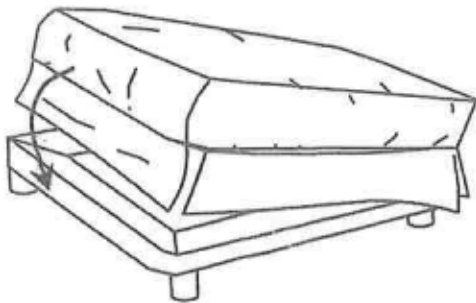

Turn over the top cushion and lay the top part on the base with the velcro matched and press down firmly.

5

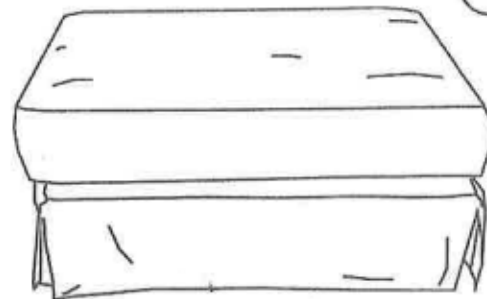

Regulate the cover and skirt,tuck the creases. When finished,your slip cover fits snugly.