

Assembly Instructions for 9102 SOFA

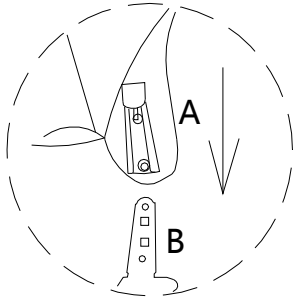

1. Slide the metal receiver over the metal post. Press both sides of back firmly downward until locked in place.

Note: Make sure all PLUGS are connected on the product before plugging power cord into power outlet. If not damage can occur.

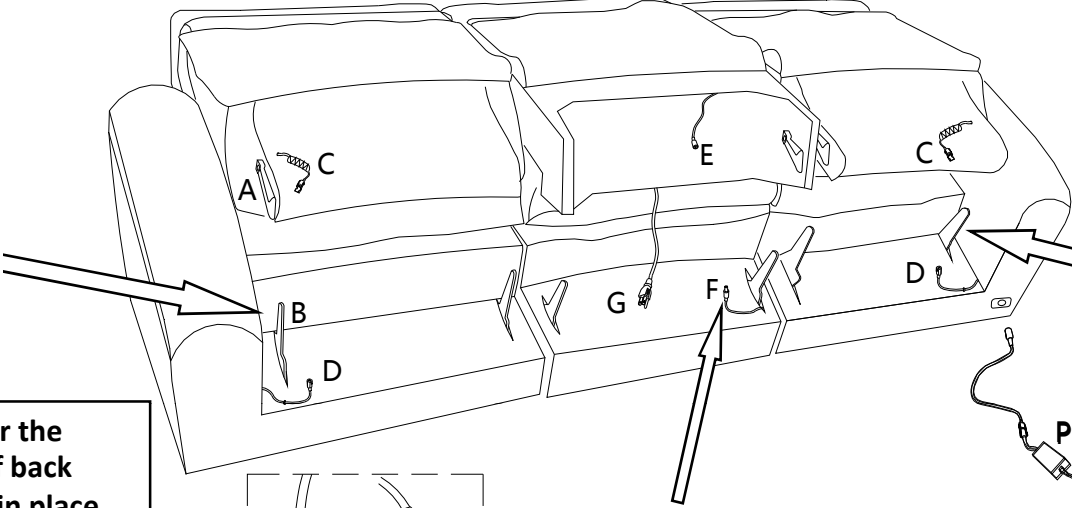

2. Locate the power cord C attached to the bottom back and connect to plug D located at the rear of seat.

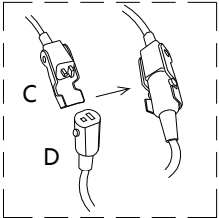

3. Locate the light cord E attached to the bottom back and connect to plug F located at the rear of seat.

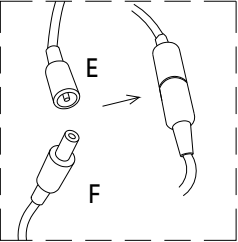

4. Locate the transformer P and connect to DC Port located at the rear of arm.

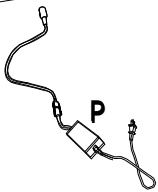

5. Attach wings
Insert the male KD Bracket into the slot of the female Bracket pressing firmly downward until the frame is tight.

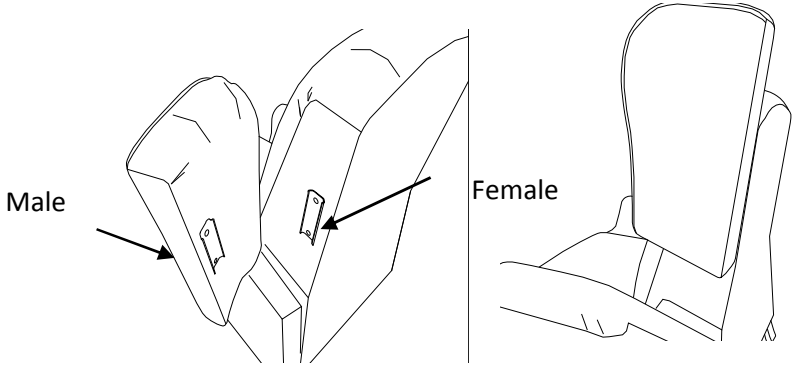

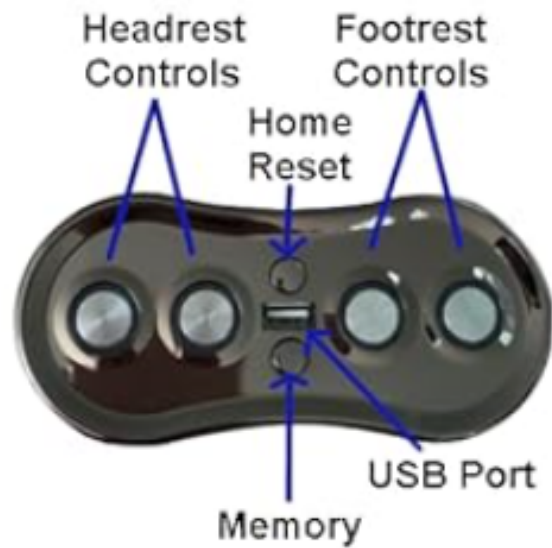

Power Controls with USB

- Hold down home button until head and footrest return to original position
- Hold down memory button until head and footrest controls flash blue. Choose your favorite position and the memory will be set

INSTRUCTION FOR MLSK46-C

A. Structure



Picture1

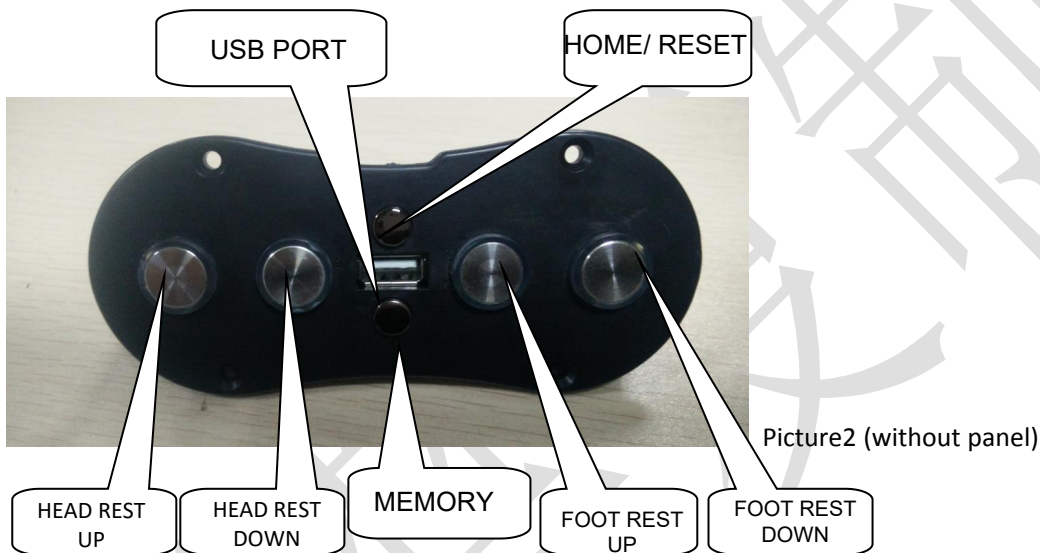

Picture2 (without panel)

B. Fixing Method

1. Direction: Put the rut side upside.
2. Use the countersink screws of ST2.9.

C. Usage

1. The switch distinguishes by left & right side based on sitting on sofa.
2. The usage of memory function:

When the sofa being adjusted to a comfortable position you fell, press the memory button for 3s till the 4-button blue lights (as picture 2) flashing for 3 times. Then the comfortable position is recorded. Next time, by pushing the memory button one time ,the sofa will go to the comfortable position that you set before ,if you want to stop the memory function right now, just press any buttons on the product. We set the memory function which only can open but can not close the seat and head motor to make sure safety. The memory will not work if any motor stop position is over the position which recored before .

3. HOME function: by pushing and hold the HOME button, the sofa will be all closed, if you release the HOME button, the sofa will stop close.

4.USB charging port:The output Voltage on the USB port is 5V and the output current is 2A.

PLEASE DO NOT USE A MULTI-BOARD OR MORE THAN TWO USB DEVICES AT ONE TIME, OR DAMAGE COULD OCCUR.