

# STYLE 2001

## OWNER'S MANUAL



# table of contents

|  |       |
|--|-------|
| Safety Precautions and Usage Statements .....          | 1-4   |
| Parts List .....                                       | 5     |
| Base and Remote Overview / Quick Reference Guide ..... | 6-7   |
| Installation Guide .....                               | 8-9   |
| Remote Control Pairing .....                           | 10    |
| Syncing Two Bases .....                                | 11    |
| Power Down Box .....                                   | 12    |
| Connecting Straps .....                                | 13    |
| Headboard Brackets .....                               | 14    |
| Troubleshooting .....                                  | 15    |
| Español .....  | 16-20 |
| Notes .....  | 21-22 |

# safety precautions and usage statements

## Attention: Important Safety Disclaimers

Read all instructions before using your adjustable base. Save these instructions.

### WARNING

Always unplug the base from the electrical outlet before servicing any part of the base. To reduce risk of electric shock, unplug the base before cleaning. To safely disconnect, ensure the base is in a flat position with all motors off, and unplug from power source.

#### SAFETY:

#### TO REDUCE THE RISK OF SHOCK, BURNS, FIRE OR INJURY:

For optimal safety and operation, plug bed base into a surge protector (not included). The bed base should only be plugged directly into a wall outlet or surge protector (strongly recommended). Always unplug the base from the electrical outlet before servicing any part of the base. To reduce risk of electric shock, unplug the base before cleaning. To safely disconnect, ensure the base is in a flat position with all motors off, and unplug from power source. Keep the power cord away from heated surfaces. Never operate the base when the air openings are blocked. Keep air openings free of lint, hair and the like. Do not drop or insert any object into any opening. Discontinue use of the bed base and contact a qualified service center if: it has a damaged cord or plug, if it is not working properly, or it has been dropped into water. Only use this bed base for its intended use as described in this manual. Do not use accessories/ attachments that are not recommended by the manufacturer. Close supervision is required when the bed base is used by or near children, convalescents, disabled persons or pets. Improper connection of the equipment can result in the risk of electrical shock, electrical fire or faulty operation of this bed base. If the plug does not fit your outlet, contact a qualified electrician to install a suitable

outlet. Unauthorized modification or failure to use a wall outlet or surge protector could void the electrical portion of your warranty.

### WARNING

- Keep bed in a flat position when not in use.
- Stay clear of moving parts while in motion.
- Before adjusting, make sure children and pets are clear of moving parts and are not under bed base.
- Do not allow children to operate bed base without adult supervision

#### PETS AND CHILDREN:

Immediately dispose of all packing materials as it may pose a smothering risk to small children and pets. To avoid injury, it is not advised to allow children and small pets to play on or under the bed. Children should not operate the bed base without adult supervision.

#### PACEMAKERS:

Some products contain Neodymium MAGNETS which may interfere with devices such as pacemakers, ICD's and any other device sensitive to magnetic fields. It is STRONGLY recommended that owners of such medical devices consult their physician prior to using products that contain Neodymium MAGNETS. It is also possible that some pacemakers may falsely interpret the optional massage feature vibrations as movement/exercise. This is a common occurrence with any product that creates a vibrating movement and may not affect the pacemaker. Please consult your physician before using the massage feature.

# safety precautions and usage statements

## ⚠ WARNING

For optimal safety and operation, plug bed base into a surge protector (not included). The bed base should only be plugged directly into a grounded wall outlet or surge protector (strongly recommended). Improper connection of the equipment can result in the risk of electrical shock, electrical fire or faulty operation of this bed base. If the plug does not fit your outlet, contact a qualified Electrician to install a suitable outlet.

### IN-HOME USE AND HOSPITAL STANDARDS:

Ergomotion adjustable bed bases are designed solely for in-home use. This base was not designed as a hospital bed and is not designed to meet hospital standards. Do not use this base with TENT TYPE oxygen therapy equipment or near explosive gases.

### ADDITIONAL SAFETY FEATURES

Casters (optional leg accessory) are equipped with locking wheels to prevent unwanted movement. Even when locked and unable to roll, it is possible for the casters to slide. Free release head and foot motors are designed to lower the mattress by retracting only with gravity, never pulling downwards, which minimizes pinch points.

### ACOUSTICS

#### LIFTING/LOWERING MECHANISMS

The lift/lower feature will emit a minimal humming sound during operation. This is normal. During operation, the lift arm wheels make contact with the platform support of the base. This contact may result in metal on metal or metal on plastic contact. This applies slight tension on the moving components and resonance is reduced to a minimum level. If excessive noise or vibration is experienced, reverse the movement action (up or down) of the base with the remote control. This should realign the base's activating mechanisms to the proper operational

position. In normal base operation, the wheels which allow the bed to maintain its distance from the wall, will make contact with the steel platform supports of the base creating a contact noise. When entering, exiting or shifting weight on the base, this contact noise may be audible as the wheels make contact. This is normal.

### MATERIALS

Ergomotion adjustable bases are constructed from various materials including woods, metals, plastics and fabrics. Tension, pressure or movement applied to the frame, platform or shroud through general use may create an audible sound.

### MASSAGE OPERATION AND LOCATION ENVIRONMENT

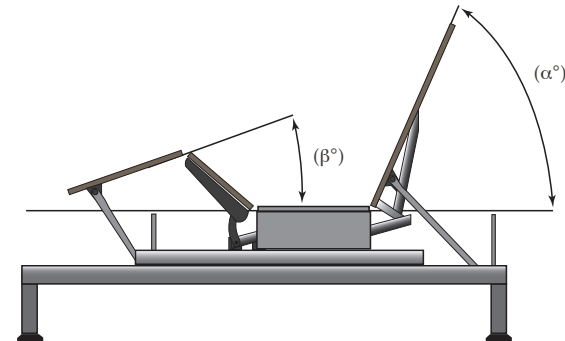

The massage feature will emit a tone during operation. This is normal. As the massage intensity level is increased, the tone will intensify. The volume of this tone is directly related to the location environment. For example, when demonstrated in a show room, the surrounding environmental noise will cover some of the massage noise. However, when installed in a home setting with wooden floors, carpeted or not, the massage volume will be more noticeable. To minimize this resonance, place a piece of carpet, or rubber caster cups, under each leg or caster of the base. It is possible to experience vibration or noise from the exterior bed

# safety precautions and usage statements

frame, headboard brackets, headboards or footboards if mounting bolts are not firmly tightened.

Levels 1-6 of massage intensity represent the revolutions of the motor per minute. Level 6 provides the maximum number of RPMs. However, this does not mean that the feeling of vibration is the strongest. Depending on the mattress material, thickness, and positioning of the user, the feeling of vibrations will differ. We encourage the user to find the massage intensity setting that suits them best. It is important to understand the physics of vibrations. Just as an engine may run rough during idle, as the RPMs increase, the vibrations change concurrently.

## **TOLERANCE**

All Ergomotion adjustable foundations, depending on make and model, are designed and manufactured to perform and function within designated quality control parameters. Bases are subject to meticulous and rigorous inspections during the quality control process to ensure bases will operate within these standards during normal operating use. Normal operating use is defined as the following: Adjustable foundation is to be operated with a mattress and load. Testing procedures require lifetime cycle tests with up to 120kg distributed load. The angle (designated “a” in figure 1) between the back section and the flat section for various configurations of the mattress support platform shall be  $\pm 3^\circ$ , which translates to a tolerance of up to  $1\frac{1}{2}^\circ$ .

The angle (designated “b” in figure 1) between the flat section and foot section for various configurations of the mattress support platform shall be  $\pm 3^\circ$ , which translates to a tolerance of up to  $\frac{3}{4}^\circ$ .

Any adjustable foundation deemed to be within these allocated tolerances is considered to have met the manufacturer’s quality control standards.

## **THAT “NEW PRODUCT” SMELL:**

Some people notice a slight odor to their new adjustable base—this can come from our material manufacturing process. This smell is normal and usually

disappears before the product reaches you. Sometimes, however, this smell may still be noticeable. It usually disappears after a few weeks, providing adequate ventilation of the product and the environment.

## **BREAK IN PERIOD:**

You can speed up the break-in period by simply spending time in the adjustable bed through activities such as reading, watching TV or playing with the kids or grandkids. The extra movement will help the adjustable base respond to weight and temperature changes. Some of the materials in our adjustable bases such as the woods, metals and plastics used in the platform, frame and components are sensitive to moisture content and temperature and may make sounds in colder environments.

## **PAIRED OPERATION:**

When operating a “paired” split base setup there may be a time latency up to 1.5 seconds between each bases articulation.

## **WEAR AND TEAR:**

Wear and tear is damage that naturally and inevitably occurs as a result of normal use or aging.

## **FABRIC CARE:**

To prolong the life of your fabric, protect from direct sunlight whenever possible. For spot cleaning, wipe area with a light damp sponge or vacuum with a soft brush attachment to remove particles. Keep at a minimum of 30cm (12 inches) away from direct heat sources. For a deeper cleaning, blot liquid spills with a clean dry cloth. Wipe with a clean cloth dampened with warm water. Do not wet excessively. A soft bristle brush may be used to remove ingrained soil. Avoid scratching by gentle brushing. Wipe with a clean cloth dampened with warm water to remove residues. Dry in shade away from direct heat. If persistent marks remain visible after cleaning, seek professional advice.

# safety precautions and usage statements

## **PRODUCT RATINGS:**

The lift motors are not designed to operate continuously for more than [2] minutes in an [18] minute time period or approximately 10% duty cycle. Attempting to circumvent or exceed this rating will shorten the life expectancy of the product and may void the warranty. The massage motors are not designed to operate continuously for more than 30 minutes at a time. Please allow the massaging system to rest for 30 minutes after automatic massage shut off before restarting.

## **WEIGHT LIMITS:**

This product is not rated to support weights in excess of 650 pounds inclusive of the mattress and bedding. The base will structurally support this weight, provided it is evenly distributed across the bed base. The adjustable base is not designed to support or lift this amount in the head or foot sections alone. Exceeding this weight restriction could damage the bed and/or cause injury and will void the warranty.

## **IMPORTANT DO'S AND DON'TS:**

### **DO:**

- Plug your adjustable base into a power surge protector.
- Evenly distribute weight when sleeping in a split setup. Uneven distribution of weight can cause the base to raise unevenly.
- Call Customer Service for any technical issues. Do not try to force the base down, this can damage the motors or frame.
- Use mild soap and water to clean your adjustable base if staining occurs.
- Keep in mind that adjustable bases are recommended to be used with adjustable friendly mattresses
- Lower to the flat (horizontal) position after use and in between presets.
- Register your warranty as soon as your adjustable base has been delivered.

### **DON'T:**

- Sit on corners/edges of base, this may warp the frame, struts or foam.
- Tilt the base on its side. This can damage the legs and/or leg screws.
- Stand or jump on the adjustable base at any time, this can damage the frame and motors.
- Drag the base to move it. Dragging the base could damage the frame, strip the nut/bolts or break the legs. Purchase castors if you plan on moving your base routinely.
- Enter and exit the adjustable base with the head and/or foot in the articulated position. Enter or exit your adjustable in the flat (horizontal) position.
- Tinker with or modify base. This will void the warranty.
- Press down on the head or foot while actuated can damage frame and motors.

### **FCC Compliance:**

This device complies with part 15 of the FCC Rules. Operation is subject to the following two conditions: (1) This device may not cause harmful interference, and (2) this device must accept any interference received, including interference that may cause undesired operation.

To comply with the FCC RF exposure requirements, no change to the antenna or the device is permitted. Any change to the antenna or the device could result in the device exceeding the RF exposure requirement and void user's right to operate the device.

Radio Frequency: 2.4 GHz

## **SAVE THESE INSTRUCTIONS.**

# parts list

**Before discarding the packing materials, ensure all the parts are accounted for.**

**All electronics and components that need to be installed are located in boxes under the base or attached to the frame.**  
*(Remote varies based on model.)*

- A) Wireless Remote Control and (3) AAA Batteries
- B) Mattress Retainer Bar (2) \*
- C) Power Cord
- D) Power Supply
- E) Power Down Box (9 volt batteries not included)
- F) Sync-Cord †
- G) Connecting Strap ♦

**Misc. Parts (not included):**

- Surge Protector
- 9 Volt Batteries

\* These items are attached to the base for shipping purposes. Carefully remove from base and set aside.

† Only included in Twin Long and Cal King Split bases.

♦ Legs are required for the installation of the connecting strap and headboard brackets. To purchase legs, connecting strap, and headboard brackets, please contact Ergomotion customer service by calling 1-844-534-3676.

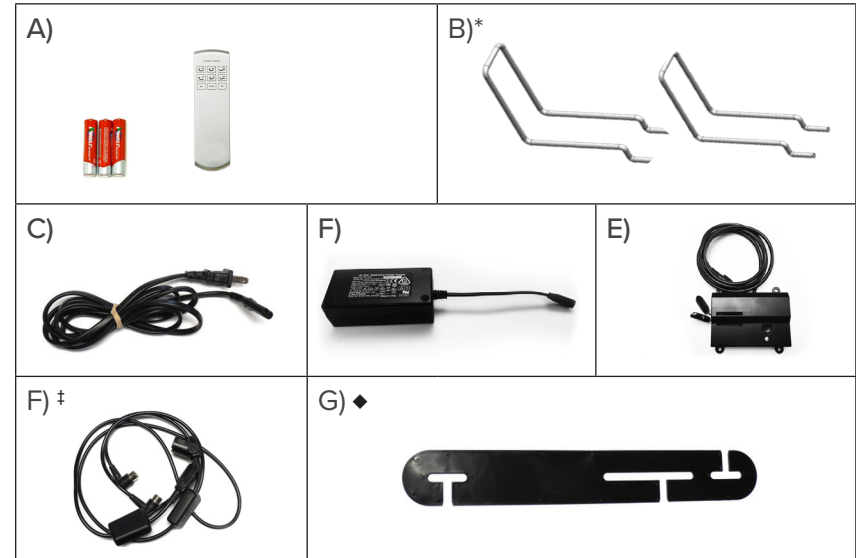

# base and remote overview

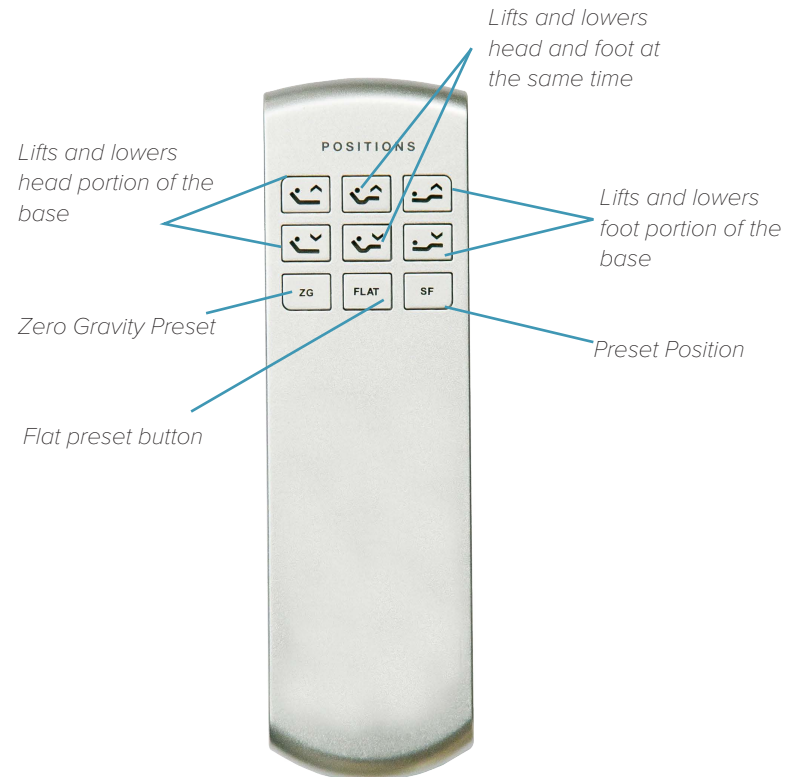
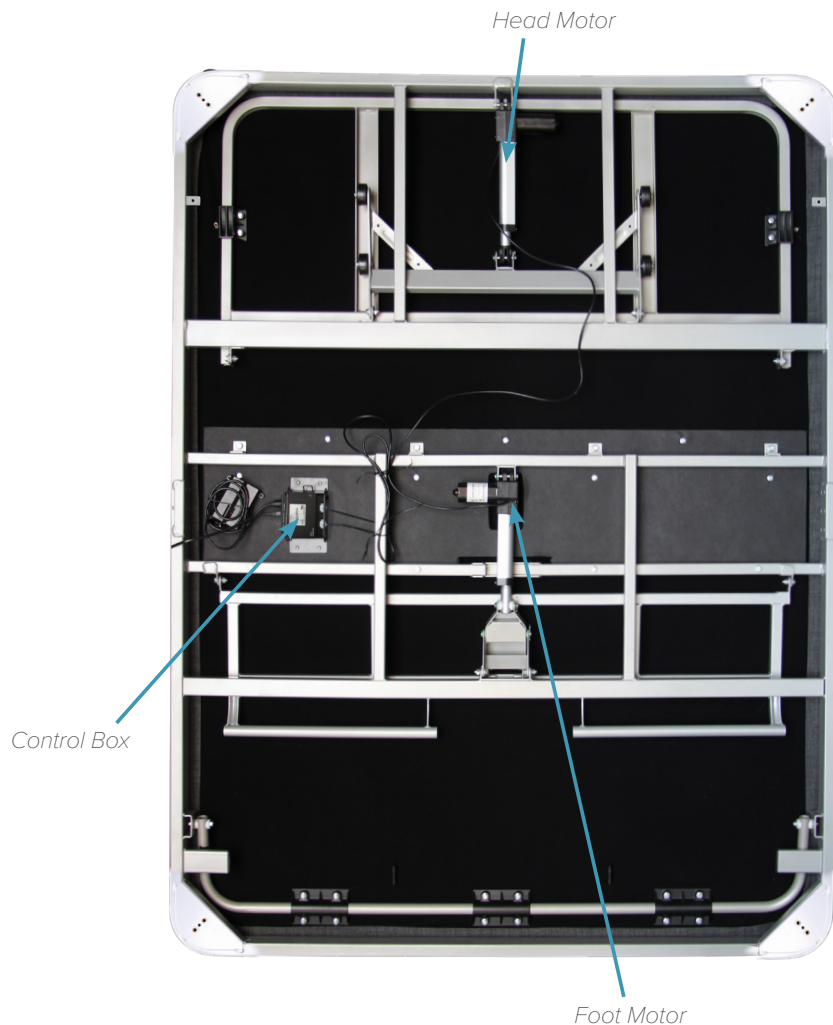

1. Press the FLAT button to return the bed base to flat position .
2. Adjust the head and foot to desired positions .
3. Press the M button until back light flashing.
4. You can reset the M Preset position button by repeating the above steps.
5. Press the FLAT and ZERO G button simultaneously until back light flashing to go back to the original position from factory.



# quick reference guide

**Not to scale. For illustration purposes only. Read all instructions before beginning installation.**

## CONTROL BOX OVERVIEW

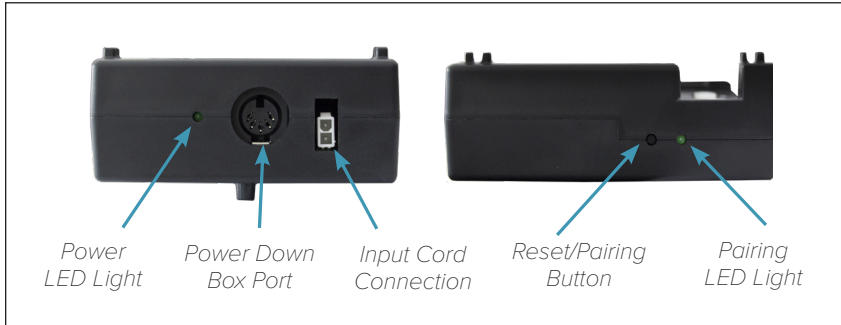

To remove control box, release metal clip and unplug cords.

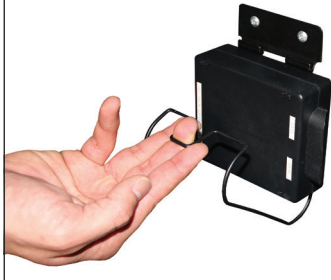

## ELECTRONICS OVERVIEW

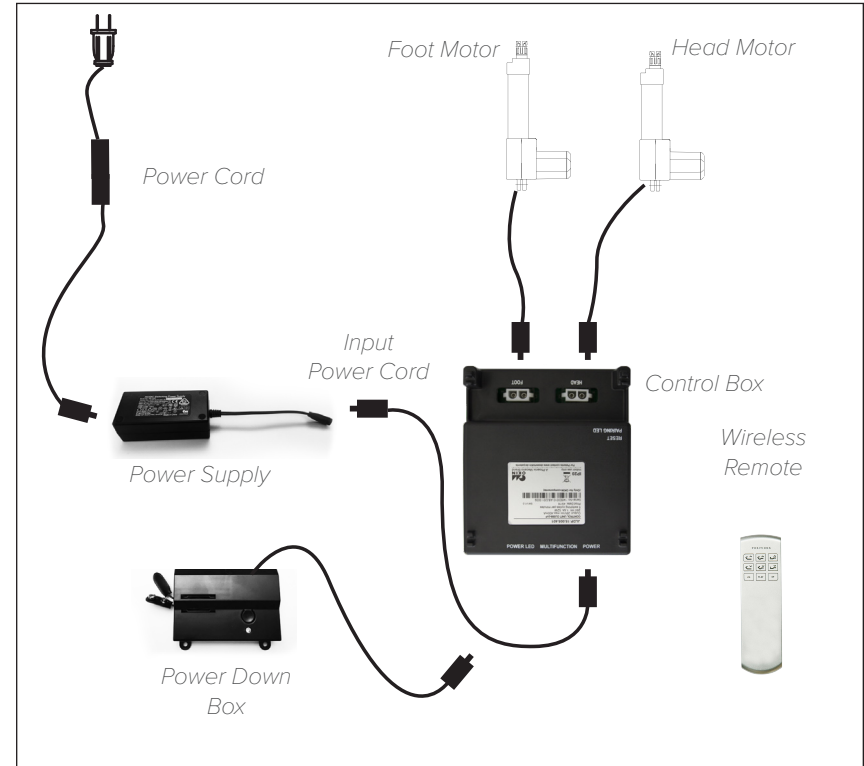

**If installing a split unit, see page 13.**

# installation guide

**Always use two people when setting up the base.**

## STEP 1

Place the bed base box in a desired location with the top of the box facing up.

Remove the binding straps and packing materials, making sure not to puncture the box with any sharp objects.

## STEP 2

Remove the bed base from the box keeping the bottom of the base facing upwards.

If setting up the base without legs, please skip to step 4.

## STEP 3

**To install Headboard Brackets (sold separately) see instructions on page 14.**

Legs are optional. To install the legs, thread the washer over the bolt of the leg with the recessed side facing the leg, and tighten by hand. Do not over tighten.



## STEP 4

**To sync two bases see detailed installation instructions on page 11.**

Locate the power down box and set it aside. Be sure that it is accessible after the base is set up.

## STEP 5

Uncoil input Power Cord (connected to Control Box's power port) and plug into Power Supply.



## STEP 6

Uncoil the Power Cord and connect to the Power Supply. Place Power Supply on the ground and extend from the base. Ensure that the Power Supply and all attached cords are directed toward the desired surge protector.



# installation guide

## STEP 7

Carefully flip the base over. Important: Two people are required to move the bed base. Do not drag across the floor. Do not rest frame on its side, excessive pressure may damage the legs (if used).

## STEP 8

Plug the power cord into a power source.

**A surge protector is recommended.**

## STEP 9

Quickly test remote functions to verify proper setup before placing mattress on base. Return the base to a flat position before placing the mattress on top.

## STEP 10

Install mattress retainer bars by inserting both ends of mattress retainers bar into holes on the platform and laying the bars down with curved side facing up.

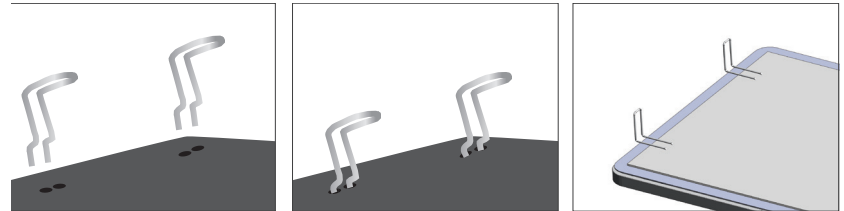

***Setup is now complete! Test all functions on remote.***

# remote control pairing

## Remote Pairing

The original remote that comes in the box is already paired to the adjustable base. No further action is required. In the event that the remote is not paired with the base, follow the steps below.

### STEP 1

Locate the Power Down Box and press the button TWICE. A light on the Battery Back Up Box will illuminate.

POWER DOWN  
Button

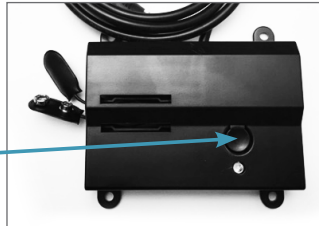

### STEP 2

Remove the back cover of the remote, press and hold down the PAIR button. The PAIR button will illuminate blue and start flashing. When the PAIR button stops flashing, the illuminated light on the Battery Backup Box will go out. Release the PAIR button. The remote is now paired to the adjustable base.

PAIR  
Button



### STEP 3

Test all remote functions. If the remote buttons do not impact the adjustable base movements, please repeat the process again.

#### \*ALTERNATE REMOTE PAIRING PROCESS!

Locate the Control Box (see base overview and quick reference guide for corresponding base) and press the Reset/Pairing button twice. A pairing LED light will illuminate green on the Control Box. On the back of the remote, press and hold the PAIR button. The PAIR button will illuminate blue and start flashing. When the PAIR button stops flashing, the green LED light on the Control Box will go out. Release the PAIR button. The remote is now paired to the adjustable base.

Reset/Pairing  
Button

Pairing  
LED Light



# syncing two bases (optional)

A Sync Cord is included with the base. Not available on Queen or Full.

The Sync Cord connects the two control boxes to a single remote for the synchronization of two bases

## STEP 1

Unplug bases from power source.

## STEP 2

Connect the male end of the sync cord to each Power Down Box.

## STEP 3

Check to ensure all cords are securely attached.

Plug bases back into the power source.

## PERFORMANCE NOTES

Both remotes will now operate both bases simultaneously. If bases become mismatched, pressing the FLAT button will re-sync the mechanical positions.

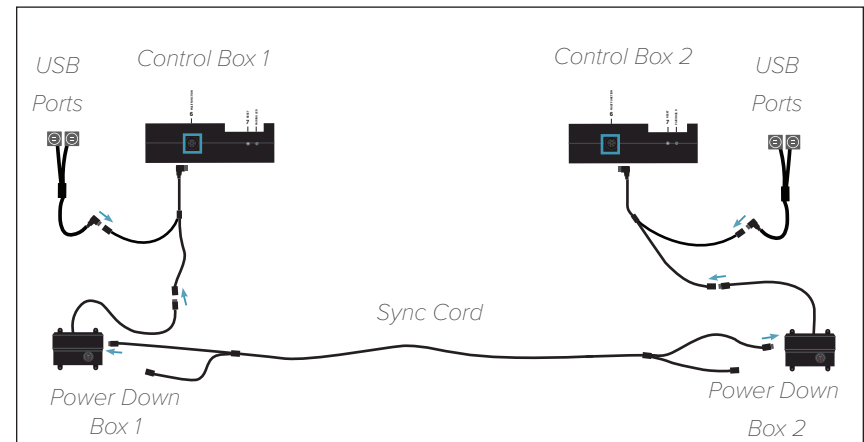
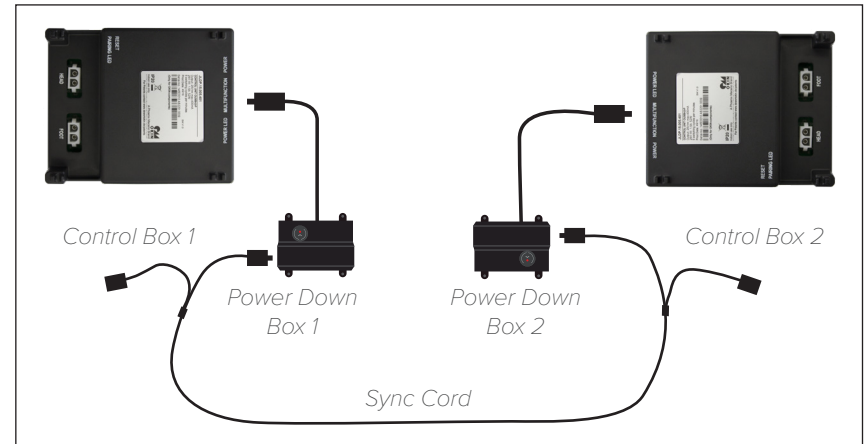

# power down box

**Store the battery box in a convenient location for emergency use.**

**Two (2) 9 Volt batteries are required to operate the power down feature and are NOT included.**

## OVERVIEW

For emergency use only, in case of a power outage.

In the event that the base is stuck in an articulated position during a power outage, the Power Down Box will return the base to a FLAT position. Batteries are not to be used for normal operation of the base.



## STEP 1

Install the 9 Volt batteries into the provided Power Down box.  
*Do not mix brand name batteries.*

## STEP 2

Press the button on the Power Down Box to lower the base to FLAT position.

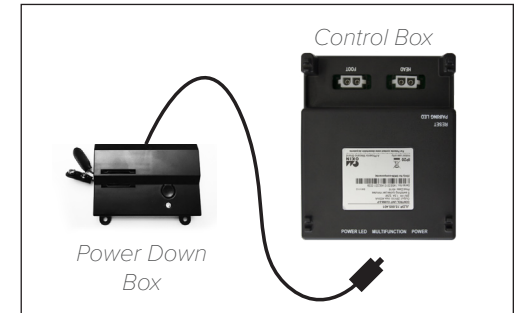

# connecting strap (optional)

**Connecting straps are secured to the base frame upon delivery.**

**Legs are required for the installation of the connecting straps.**

## STEP 1

*Legs are required for the installation of the connecting strap.*

With the bases in their desired location, slightly loosen both legs to allow the strap to fit on the leg bolt, between the leg washer and frame.



## STEP 2

Slide side (a) of the connecting strap onto leg bolt. Swing the strap and connect side (b) to the leg bolt. Secure the strap by shifting to the left.



## STEP 3

Re-tighten legs. Do not over tighten. Use the remaining strap and repeat on other end of the base.

# headboard bracket installation guide (optional)

**Headboard Brackets are optional accessories and are not included.**

**A 9/16" (14 mm) & 1/2" (13 mm) socket or wrench and legs are necessary to complete installation.**

## STEP 1

*Legs are required for the installation of the headboard brackets.*

- a.) Align the hole in the bracket to the brass sleeve into which the leg threads. Hold the bracket in place and screw the leg into the base until it is snug. **DO NOT OVERTIGHTEN.** Too much force may cause the leg to spin freely.
- b.) Align the tab with the hole in the frame (located towards the foot of the base) and use a short bolt and nut to secure the bracket. Make sure the bolt is tight.

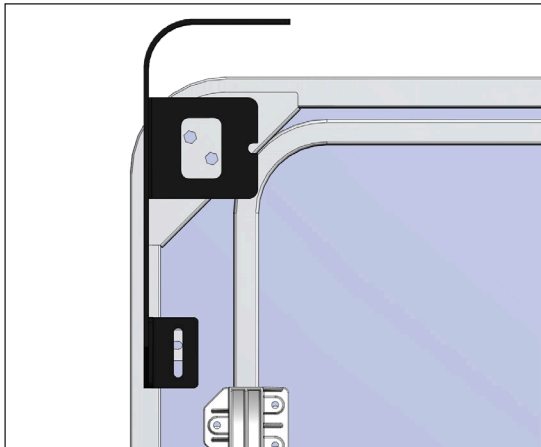

## STEP 2

Attach the plastic spacer and T-Bracket.

- a.) Measure the distance between the mounting holes on the headboard and install the spacer and attachment plate to accommodate the headboard.
- b.) To install the plastic spacer and attachment plate, you will need (2) long bolts and (2) nuts. Place the spacer and attachment plate in the desired location and slip the bolts through the holes with the head of the bolt facing outward. Position the bolts diagonally on the spacer. Use the 9/16" (14 mm) socket and wrench to tighten the bolts.

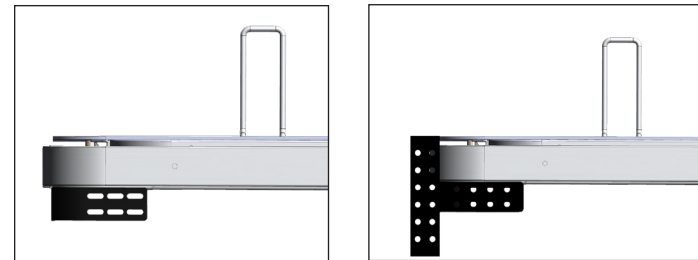

## STEP 3

You may now connect your headboard to the attachment plates using the remaining short bolts and nuts to secure it to the brackets. The heads of the bolts will face outward. Use a 9/16" (14mm) socket and 1/2" (13mm) wrench to tighten the bolts.



# troubleshooting

- Check under the bed base to verify that the wired connections are secure and that there are no cords or bedding obstructing the movement of the base.
- Check to ensure the green LED light is illuminated on the control box. If there is no light, verify that the input and power cords are properly connected.
- Unplug the base for 1 hour to reset the electronic components.
- Plug bed base into a different electrical outlet, or test current outlet with another working appliance (a grounded, electrical surge protector is recommended).
- Remove and replace full batteries in the remote control and re-pair the remote to the base (see page 10).