















List of Parts For 1 Set

01		Table Top	1
02		Pedestal	1
03		Leg	4
04		Supporting Rail	2
05		Mounting Plate	1

List of Hardware For 1 Set

a		Flat Washer 5/16" x 22mm	12
b		Spring Washer 5/16"	12
c		Hexagon Nut	12
d		Spanner	1
e		JCBC Bolt M6 x 45mm	12
f		Allen Key M4	1
g		Flat Washer 1/2" x 13mm	6
h		Spring Washer 1/4"	12
i		Flat Washer 1/4" x 18mm	6

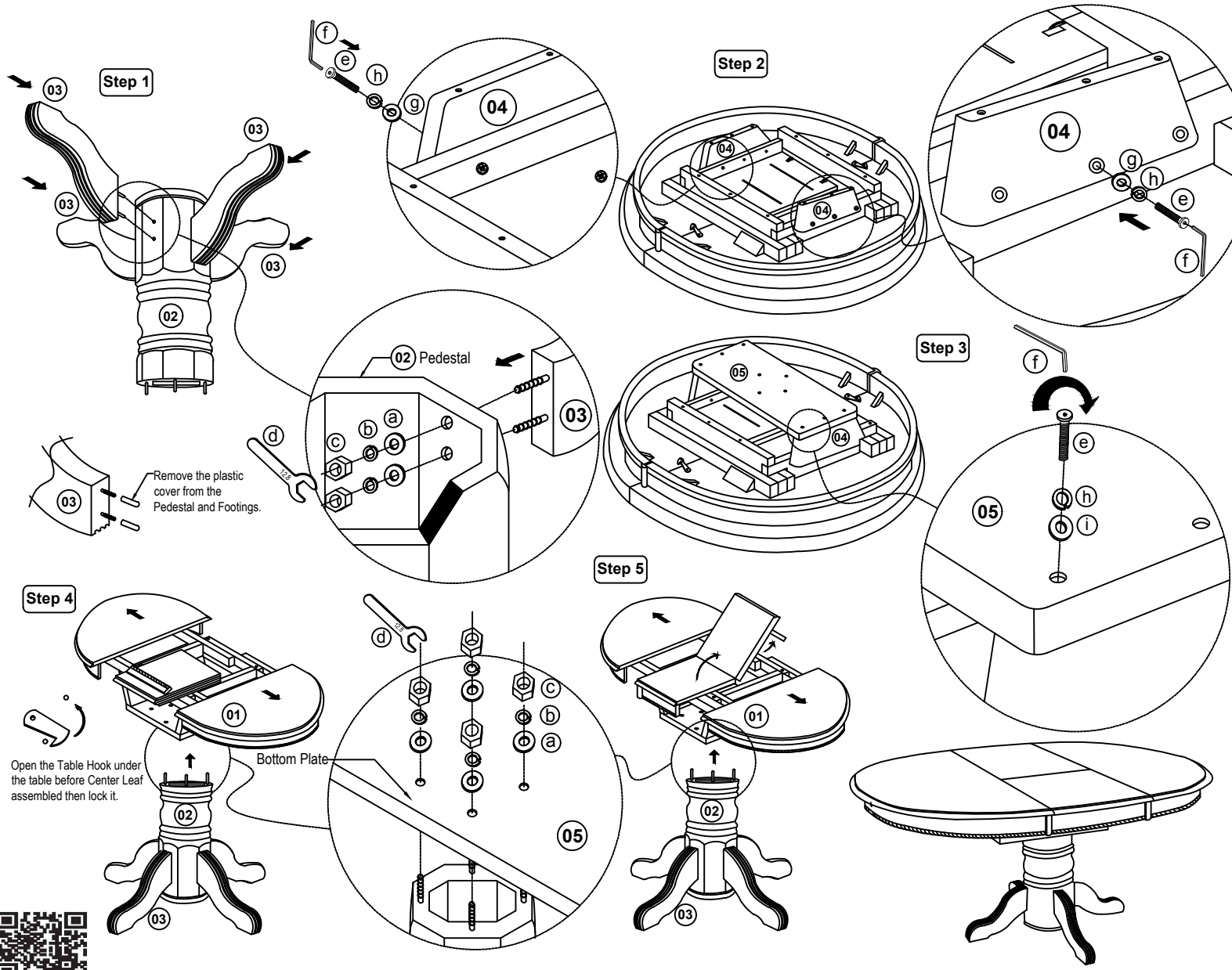

IMPORTANT NOTES:

- Keep all hardware and small parts out of reach of children.
- Remove all staples and packing straps before you start to assemble.
- Do not discard main cartons and wrapping material until assembly is complete.
- Check to be sure you have all parts and hardware.
- Place all wooden parts on a clean soft surface to avoid parts from being scratched.
- Do not tighten all screws / bolts until completely assembled.
- Check tightness 3x/year, with use screws can become loose.
- Do not attempt to repair or modify parts that are broken or defective. Please contact us immediately.
- Enjoy your new furniture!

