

**Step 1**

Remove the plastic cover from the Pedestal and Bun Leg.

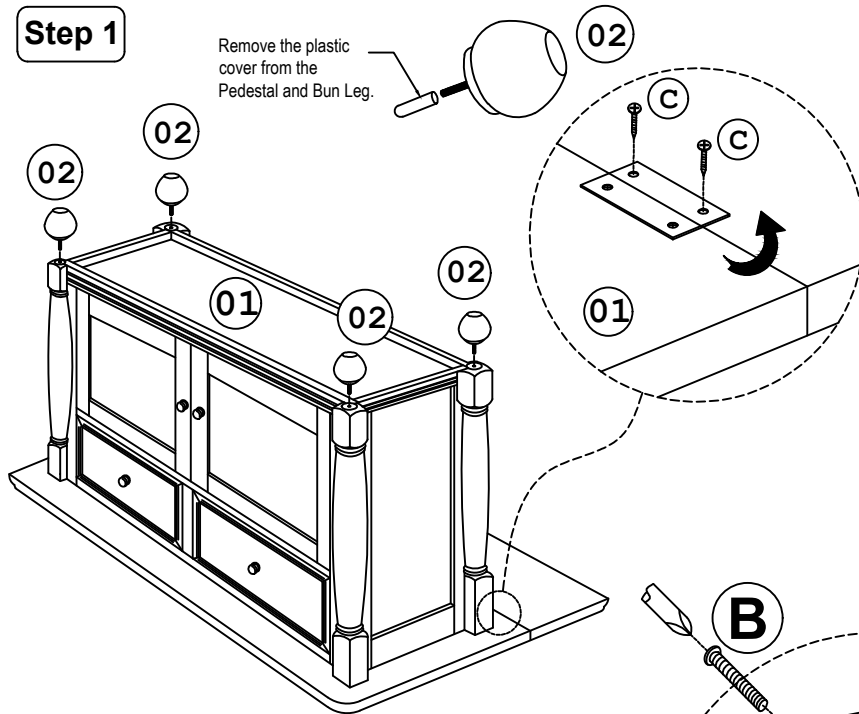

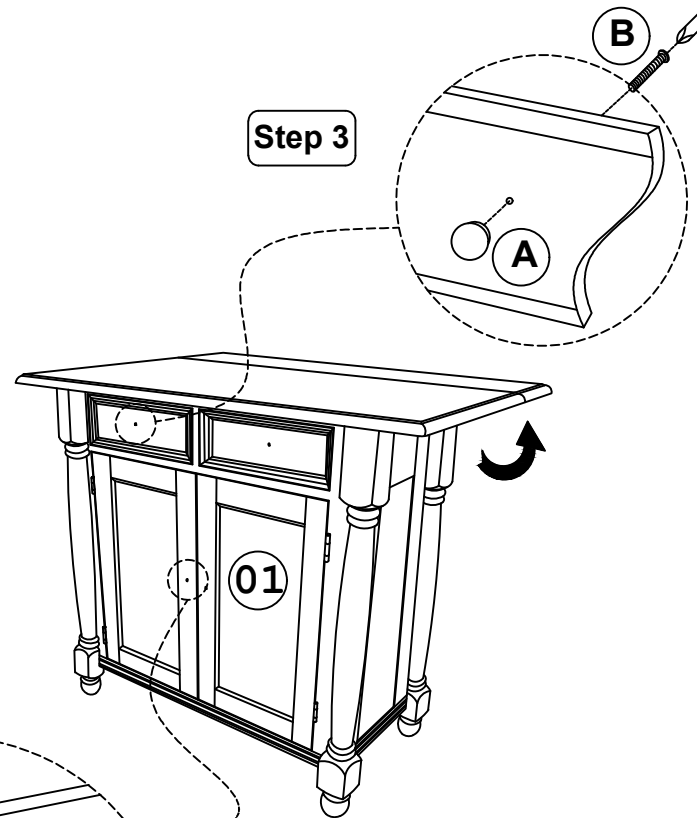

**Step 3**



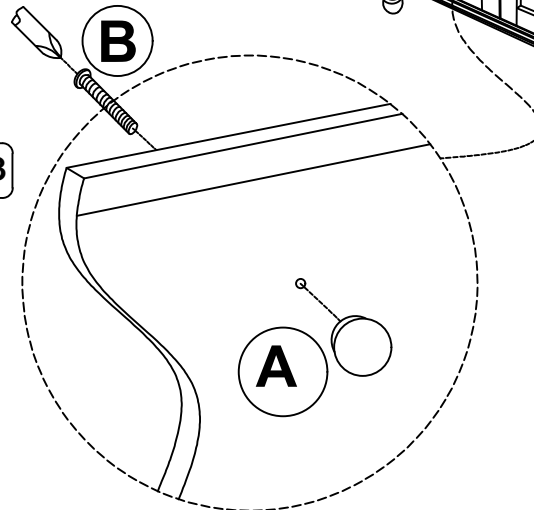

**Step 3**



List of Parts For 1 Set

01		CABINET	1
02		BUN LEG	4









List of Hardware For 1 Set

a		WOOD HANDLE	4
b		THMS SCREW 5/32" x 25mm	4
c		CSK CB SCREW M3.5 x 16mm	6

**IMPORTANT NOTES:**

- Keep all hardware and small parts out of reach of children.
- Remove all staples and packing straps before you start to assemble.
- Do not discard main cartons and wrapping material until assembly is complete.
- Check to be sure you have all parts and hardware.
- Place all wooden parts on a clean soft surface to avoid parts from being scratched
- Do not tighten all screws / bolts until completely assembled.
- Check tightness 3x's/year, with use screws can become loose.
- Do not attempt to repair or modify parts that are broken or defective. Please contact us immediately.
- Enjoy your new furniture!



Parts		QTY
Top Seat Unit (Pre-Assembled)		1
Base (Pre-Assembled)		1
Swivel Plate		1
Seat Machine Bolts		4
Lock Washers		4
Flat Washers		8
#10 Philips Screws		4
4mm Allen Wrench		1

## BEFORE YOU BEGIN

- Check to be sure that you have all parts and hardware
- Place all wooden pieces on a clean and smooth surface like a carpet to avoid parts being scratched
- Do not tighten all screws/ bolts until completely assembled
- \*Swivel plate top & bottom are pre-turned 90-degrees prior to installation. To troubleshoot swivel turning issues, please place swivel plate on your floor, use packaging carton to protect the surface, step on swivel TOP to twist using your body weight
- If missing parts or have questions, please email [info@sunsettrading.com](mailto:info@sunsettrading.com) or call Sunset Trading 877-364-8464, M-F 8am-4pm EST.

(Fig 1)



**Step 1.** Place swivel on base with 'TOP FRONT' markings on swivel facing upward. Attach swivel to base using four (4) #10 Philips screws and four (4) flat washers. Tighten with a #10 Philips screwdriver (Not Provided). **(Fig 1)**

(Fig 2)



**Step 2.** Place seat upside down on table or bench (lay a towel down to protect from scratches) or on the edge of mattress. Flip base upside down and place on top of Seat Unit bottom. Line up the four (4) slots in the swivel top with the four (4) nut inserts that are mounted in the seat. **(Fig 2)**

**\*IMPORTANT:** Make note of marking on top of swivel that reads 'TOP FRONT'. This side of the swivel must be mounted toward the front of the barstool seat in order to provide proper angle for sitting.

(Fig 3)

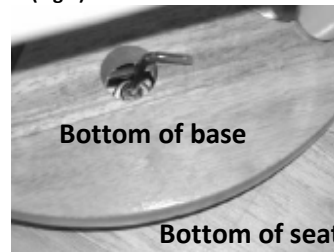

**Step 3.** Put one (1) Lock Washer and one (1) Flat Washer on each Seat Machine Bolt. Attach the swivel to the seat bottom through the access hole in the bottom of the base Unit with all four (4) bolts. **(Fig 3)**

**Step 4.** Screw all 4 bolts in half way with Allen wrench provided. Turning base unit as needed to access the nuts that are inserted on the barstool seat. Tighten all bolts fully when done. Assembly is complete!

