

**METAL CONNECTOR FITTING INSTRUCTION**

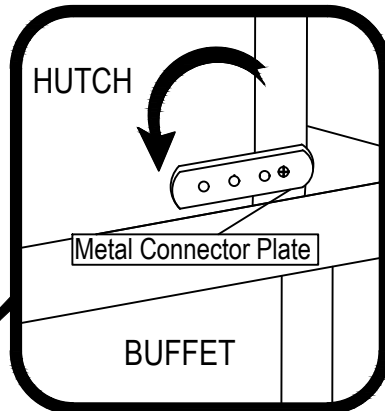

**STEP 1**

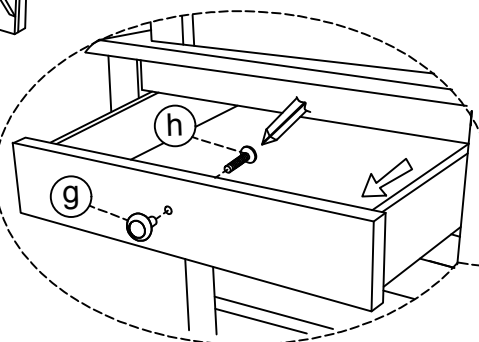

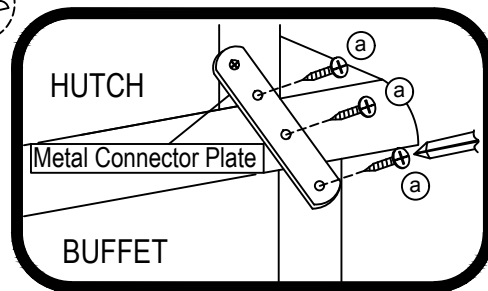









**STEP 2**



List of Parts For 1 Set

01		HUTCH	1
02		BUFFET	1

List of Hardware For 1 Set

a		CSKCB SCREW M4 x 20mm	6
b		GLASS PACK (SHELF) - LONG	2
c		GLASS PACK (SHELF) - SHORT	4
d		GLASS PACK DOOR	3
e		GLASS PACK SIDE	6
f		SHELF SUPPORT	4
g		WOOD KNOB	8
h		KNOB SCREW	8
i		LIGHT FIXTURE	2
j		CSKCB SCREW M3 x 16mm	6

**IMPORTANT NOTES:**

- Keep all hardware and small parts out of reach of children.
- Remove all staples and packing straps before you start to assemble.
- Do not discard main cartons and wrapping material until assembly is complete.
- Check to be sure you have all parts and hardware.
- Place all wooden parts on a clean soft surface to avoid parts from being scratched.
- Do not tighten all screws / bolts until completely assembled.
- Check tightness 3x's/year, with use screws can become loose.
- Do not attempt to repair or modify parts that are broken or defective. Please contact us immediately.
- Enjoy your new furniture!

