

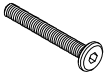

CROSSING LAKES MIRROR

Assembly Instructions

Made in Viet Nam

Components and Hardware List

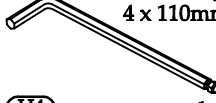
Allen Head Bolt Ø6 x 45mm  (H1) 8pcs	Lock Washer Ø9 x Ø13mm  (H2) 8pcs	Flat Washer Ø8 x Ø20mm  (H3) 8pcs	Allen Key 4 x 110mm  (H4) 1pc
--	---	---	--

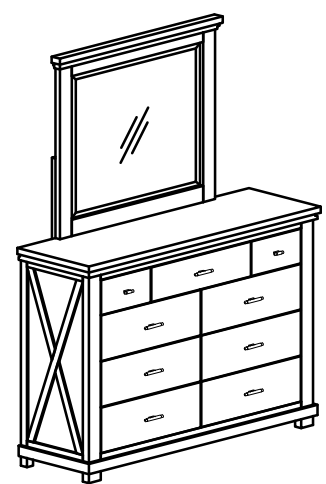
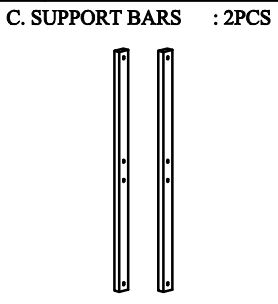
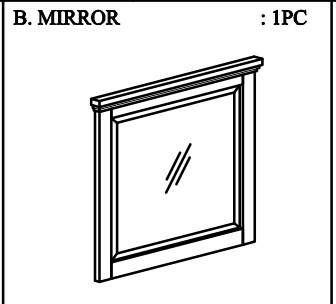
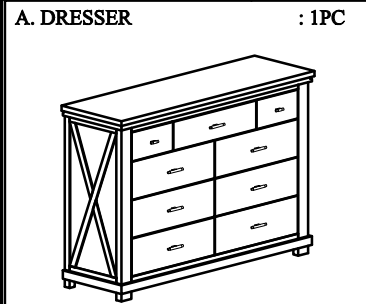

Be sure to check all packing material carefully for small parts, which may have come loose inside the carton during shipment.

