

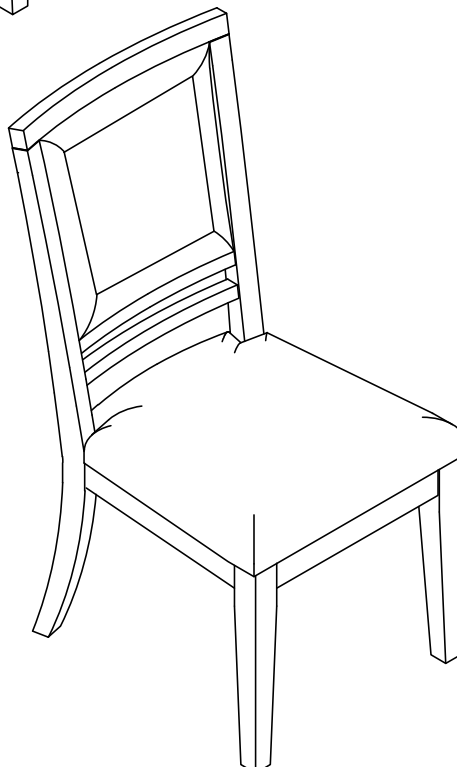









Finish Assembly



List of Parts For 1 Set

Code	Figure	Part	Qty.
01		Chair back	1
02		Seat frame	1
03		Front legs	2

List of Hardware For 1 Set

Code	Figure	Part	Qty.
a		Bolts Φ5/16" x 76mm	4
b		Bolts Φ5/16" x 50mm	4
c		Bolts Φ5/16" x 38mm	2
d		Flat Washers Φ5/16"x19mm	10
e		Lock Washers Φ5/16"	10
f		Allen Wrench M4	1

IMPORTANT NOTES:

- Keep all hardware and small parts out of reach of children.
- Remove all staples and packing straps before you start to assemble.
- Do not discard main cartons and wrapping material until assembly is complete.
- Check to be sure you have all parts and hardware.
- Place all wooden parts on a clean soft surface to avoid parts from being scratched
- Do not tighten all screws / bolts until completely assembled.
- Check tightness 3x's/year, with use screws can become loose.
- Do not attempt to repair or modify parts that are broken or defective. Please contact us immediately.
- Enjoy your new furniture!

