







List of Parts For 1 Set

Code	Figure	Part	Qty.
01		Mirro	1
02		Support Bar	2

List of Hardware For 1 Set

Code	Figure	Part	Qty.
a		Bolts Φ1/4" x 35mm	8
b		Lock Washers Φ1/4"	8
c		Flat Washers Φ1/4"x19mm	8
d		Allen Wrench M4	1

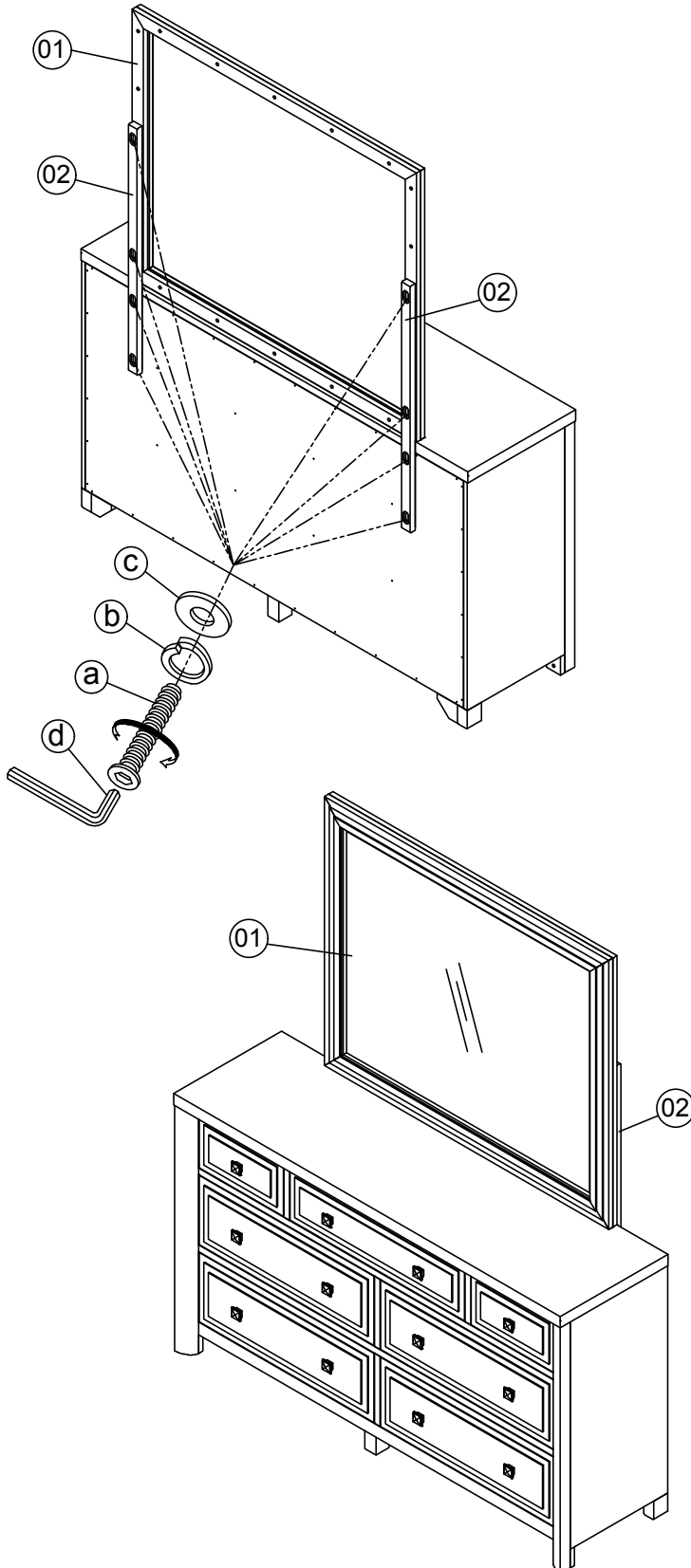

 **IMPORTANT NOTES:**

- Keep all hardware and small parts out of reach of children.
- Remove all staples and packing straps before you start to assemble.
- Do not discard main cartons and wrapping material until assembly is complete.
- Check to be sure you have all parts and hardware.
- Place all wooden parts on a clean soft surface to avoid parts from being scratched
- Do not tighten all screws / bolts until completely assembled.
- Check tightness 3x's/year, with use screws can become loose.
- Do not attempt to repair or modify parts that are broken or defective. Please contact us immediately.
- Enjoy your new furniture!

