

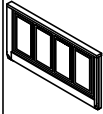

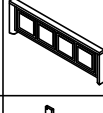







701 E Industrial Pk Dr
Manchester, NH 03109
sunsettrading.com





List of Parts For 1 Set

Code	Figure	Part	Qty.
01		Head Board	1
02		Foot Board	1
03		Head Board Left Post	1
04		Head Board Right Post	1
05		Side Rails	2
06		Slats	4
07		Slat Support Legs	4

List of Hardware For (HB) 1 Set

Code	Figure	Part	Qty.
a		Bolts Φ5/16" x 38mm	8
b		Lock Washers Φ5/16"	8
c		Flat Washers Φ5/16"x19mm	8
d		Allen Wrench M4	1

List of Hardware For (SR) 1 Set

Code	Figure	Part	Qty.
e		Half Moon Washers Ø5/16"	8
f		Lock Washers Φ5/16"	8
g		Hex Nuts Φ5/16"	8
h		Open Wrench Ø5/16"	1
i		Hanger Bolts Φ5/16"x89mm	8

List of Hardware For (FB) 1 Set

Code	Figure	Part	Qty.
J		Screws #8*25mm	8

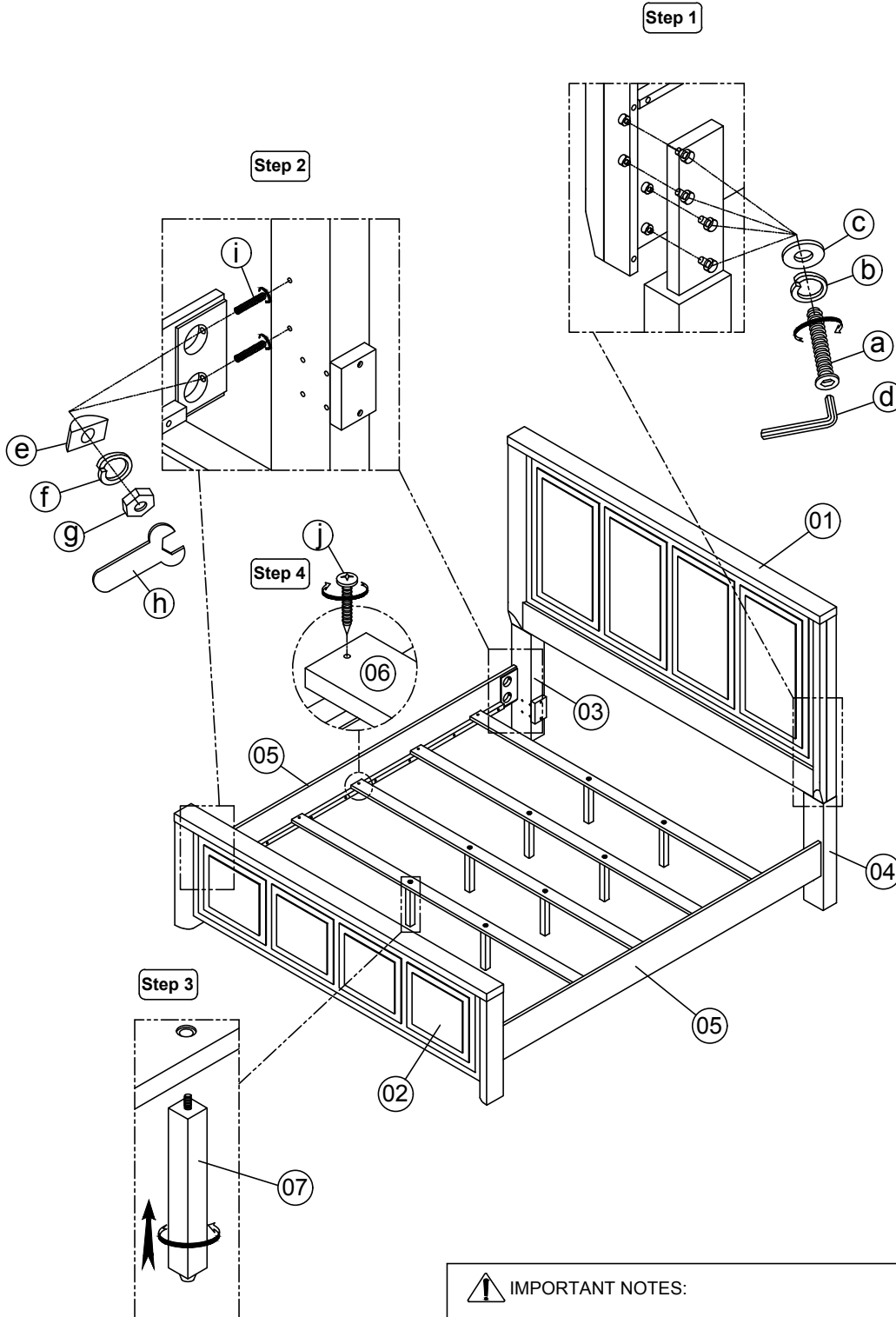

IMPORTANT NOTES:

- Keep all hardware and small parts out of reach of children.
- Remove all staples and packing straps before you start to assemble.
- Do not discard main cartons and wrapping material until assembly is complete.
- Check to be sure you have all parts and hardware.
- Place all wooden parts on a clean soft surface to avoid parts from being scratched.
- Do not tighten all screws / bolts until completely assembled.
- Check tightness 3x's/year, with use screws can become loose.
- Do not attempt to repair or modify parts that are broken or defective. Please contact us immediately.
- Enjoy your new furniture!

